

Product Name	Part No.
WaterProof M6 Female 2P	JTWP-F202-6S110
WaterProof M6 Female 3P	JTWP-F303-6S110
WaterProof M6 Female 4P	JTWP-F604-6S110
WaterProof M6 Female 5P	JTWP-F505-6S110
WaterProof M6 Female 6P	JTWP-F006-6S110

1. Material:
 Housing: PBT+15%GF
 Terminal: Brass, Gold

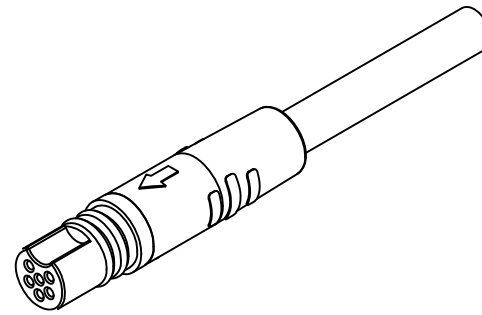

Note:

- Electrical Performance
 - Rated current :2.0 ~ 3.0 A
 - Rated Voltage : 48V
 - Insulation resistance : $\geq 20M\Omega$
 - Contact resistance : $\leq 10m\Omega$
- Mechanical Performance
 - Durability Repeated : Insert and withdraw up to 200 cycles
- Environmental Performance
 - Ingress Protection : IP67
 - Temperature Range - Operating : $-40^{\circ}C \sim +80^{\circ}C$
- Material
 - CABLE: 28~26AWG
 - SR: Black PVC

PIN	2P	3P	4P	5P	6P
	1 WT 2 BK	1 BL 2 BK 3 GN	1 PL 2 PK 3 GR 4 OR	1 PL 2 PK 3 YL 4 GR 5 OR	1 RD 2 BK 3 BL 4 GN 5 BR 6 橙色
COLOR	RED	ORANGE	BLUE	GREEN	BLACK
		TOLERAMCE UNLESS SPECIFIED		朝富科技股份有限公司 JOIN TEK JOIN TEK CORPORATION CO., LTD.	
				UNIT SHEET VER.	
				1/1 AO	
		日期 2022.08.16		名稱 : M6 Waterproof Connector	
		審核		TITLE Female 2~6PIN	
更改 REV.		設 變 內 容 MODIFICATION		料 號 : JTWP-FXXX-6S110	
		修改 核准 DRAWN APPROVED		PART NO.	
		製 圖		BEAR	

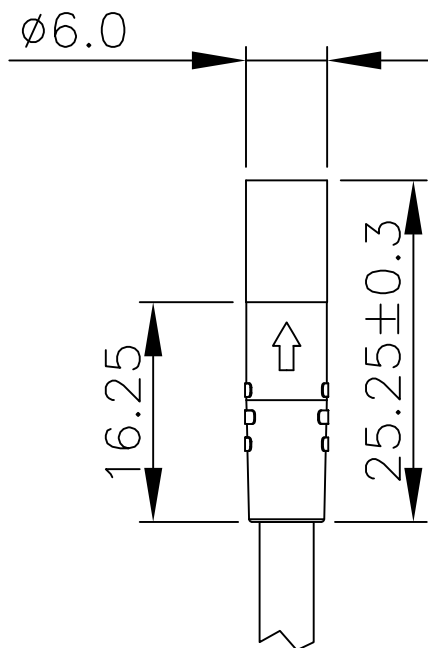
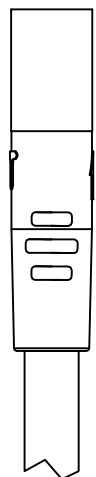

Product Name	Part No.
WaterProof M6 Male 2P	JTWP-M202-6S110
WaterProof M6 Male 3P	JTWP-M303-6S110
WaterProof M6 Male 4P	JTWP-M604-6S110
WaterProof M6 Male 5P	JTWP-M505-6S110
WaterProof M6 Male 6P	JTWP-M006-6S110

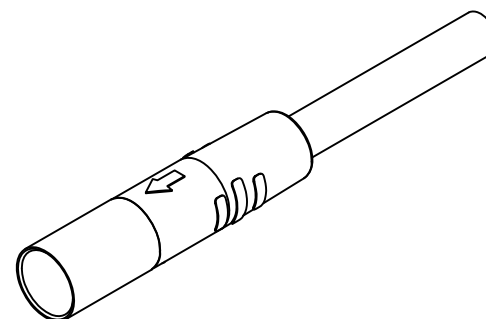

1. Material:
 Housing: PBT+15%GF
 Terminal: Brass, Gold
 Shell: Brass, Nickel

Note:

- Electrical Performance
 - Rated current :2.0 ~ 3.0 A
 - Rated Voltage : 48V
 - Insulation resistance : $\geq 20M\Omega$
 - Contact resistance : $\leq 10m\Omega$
- Mechanical Performance
 - Durability Repeated : Insert and withdraw up to 200 cycles
- Environmental Performance
 - Ingress Protection : IP67
 - Temperature Range - Operating : $-40^{\circ}C \sim +80^{\circ}C$
- Material
 - CABLE: 28~26AWG
 - SR: Black PVC

PIN	2P	3P	4P	5P	6P
COLOR	RED	ORANGE	BLUE	GREEN	BLACK
		TOLERAMCE UNLESS SPECIFIED		朝富科技股份有限公司 JOIN TEK JOIN TEK CORPORATION CO., LTD.	
		LINEAR ANGLE .X ± 0.30 X.' ± 5' .XX ± 0.20 .X' ± 2' .XXX ± 0.10 .XX' ± 1'		UNIT SHEET VER. 1/1 AO	
		日期 2022.08.16		名稱 : M6 Waterproof Connector Male TITLE 2~6PIN	
A0	New Release	審核		料號 : JTWP-MXXX-6S110 PART NO.	
更改 REV.	設 變 內 容 MODIFICATION	修改 DRAWN	核准 APPROVED	製 圖	Jason

Product Name	Part No.
WaterProof M6 Female 7P	JTWP-F007-6S110

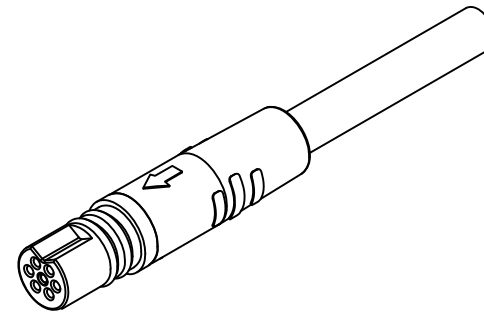
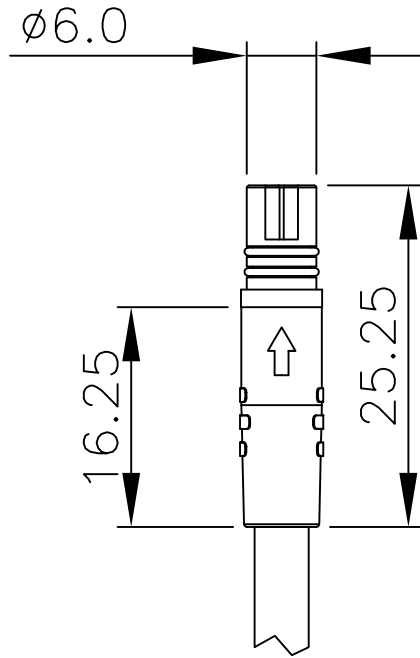
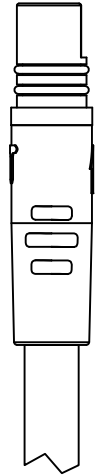

1. Material:
Housing: PBT+15%GF
Terminal: Brass, Gold

Note:

1. Electrical Performance
 - 1.1 Rated current :2.0 ~ 3.0 A
 - 1.2 Rated Voltage : 48V
 - 1.3 Insulation resistance : $\geq 20M\Omega$
 - 1.4 Contact resistance : $\leq 10m\Omega$
2. Mechanical Performance
 - 2.1 Durability Repeated : Insert and withdraw up to 200 cycles
3. Environmental Performance
 - 3.1 Ingress Protection : IP67
 - 3.2 Temperature Range - Operating : $-40^{\circ}C \sim +80^{\circ}C$
4. Material
 - 4.1 CABLE: 28~26AWG
 - 4.2 SR: Black PVC

PIN	7P
COLOR	BLACK

		TOLERAMCE UNLESS SPECIFIED		朝富科技股份有限公司 JOIN TEK JOIN TEK CORPORATION CO., LTD.		
		LINEAR	ANGLE			
		.X ± 0.30	.X' ± 5'			
		.XX ± 0.20	.X' ± 2'			
		.XXX ± 0.10	.XX' ± 1'	UNIT SHEET VER. 1/1 AO		
		日期	2023.05.24	名稱 : M6 Waterproof Connector		
AO New Release		審核		TITLE Female 7PIN		
更改 REV.	設 變 內 容 MODIFICATION	修改 DRAWN	核准 APPROVED	製 圖	BEAR	料 號 : JTWP-FXXX-6S110 PART NO.

Product Name	Part No.
WaterProof M6 Male 7P	JTWP-M007-6S110

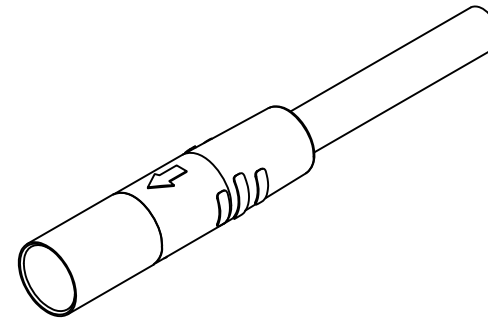
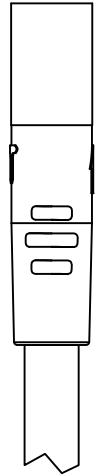
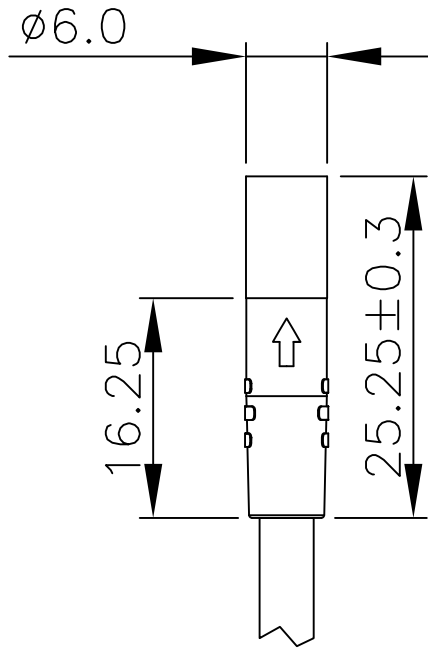

1. Material:
Housing: PBT+15%GF
Terminal: Brass, Gold
Shell: Brass, Nickel

Note:

1. Electrical Performance
 - 1.1 Rated current :2.0 ~ 3.0 A
 - 1.2 Rated Voltage : 48V
 - 1.3 Insulation resistance : $\geq 20M\Omega$
 - 1.4 Contact resistance : $\leq 10m\Omega$
2. Mechanical Performance
 - 2.1 Durability Repeated : Insert and withdraw up to 200 cycles
3. Environmental Performance
 - 3.1 Ingress Protection : IP67
 - 3.2 Temperature Range - Operating : $-40^{\circ}C \sim +80^{\circ}C$
4. Material
 - 4.1 CABLE: 28~26AWG
 - 4.2 SR: Black PVC

PIN	7P
COLOR	BLACK

TOLERAMCE UNLESS SPECIFIED	
LINEAR	ANGLE
.X ± 0.30	X.' ± 5'
.XX ± 0.20	.X' ± 2'
.XXX ± 0.10	.XX' ± 1'
日期	2023.05.24
AO New Release	審核
更改 REV.	設 變 內 容 MODIFICATION
修改 DRAWN	核准 APPROVED
製 圖	Jason

朝富科技股份有限公司
 JOIN TEK CORPORATION CO., LTD.

UNIT	SHEET	VER.
	1/1	AO

名稱 : M6 Waterproof Connector Male
 7PIN
 料號 : JTWP-MXXX-6S110
 PART NO.

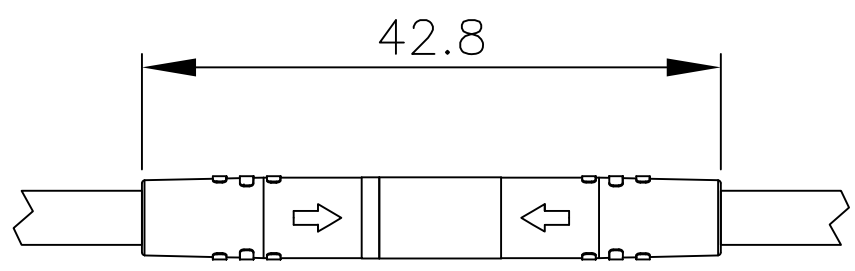

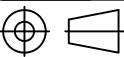
				TOLERAMCE UNLESS SPECIFIED		 朝富科技股份有限公司 JOIN TEK CORPORATION CO., LTD.					
				LINEAR	ANGLE						
				.X ± 0.30	X.' ± 5'						
				.XX ± 0.20	.X' ± 2'						
				.XXX ± 0.10	.XX' ± 1'						
				日期	2023.05.24		 UNIT SHEET VER. 1/1 A0				
A0	New Release			審核			名稱： M6 Waterproof Connector TITLE 2~7PIN				
更改 REV.	設 變 內 容 MODIFICATION	修改 DRAWN	核准 APPROVED	製 圖	BEAR		料號： PART NO.				