

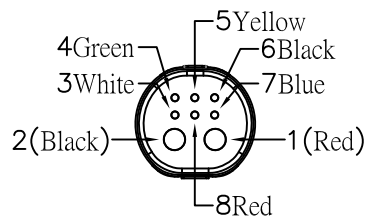

WPB25-24M 2+4

WPB25-25M 2+5



WPB25-26M 2+6

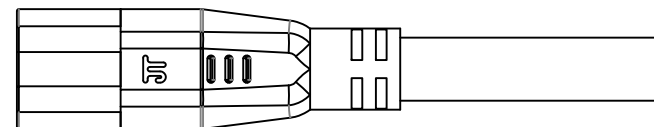
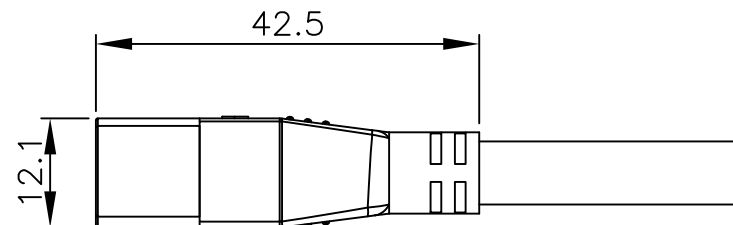
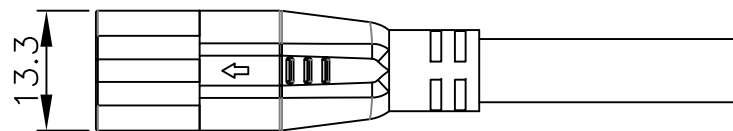
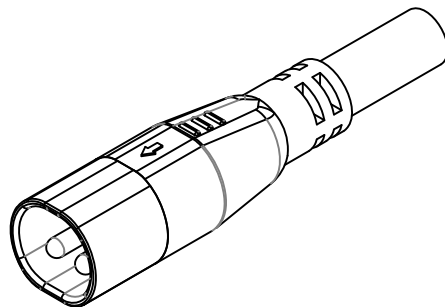
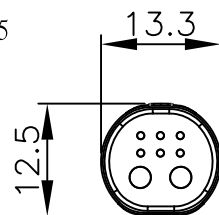

**Note:**

**1. Electrical Performance**

- 1.1 Rated current : 1~2 >= 25A / 4~8 >= 2A
- 1.2 Rated Voltage : 60 V
- 1.3 Insulation resistance : >= 20MΩ
- 1.4 Contact resistance : <= 10mΩ

**2. Mechanical Performance**

- 2.1 Durability Repeated : Insert and withdraw up to 100 cycles

**3. Environmental Performance**

- 3.1 Ingress Protection : IP67
- 3.2 Temperature Range - Operating : -40°C ~ +80°C

**4. Cables Shall Be 100% Tested For Opens And Short And Miss.**

|            |                         |                            |                |   |       |  |   |       |      |
|------------|-------------------------|----------------------------|----------------|---|-------|--|---|-------|------|
|            |                         | TOLERAMCE UNLESS SPECIFIED |                |  <b>朝富科技股份有限公司</b><br>JOIN TEK CORPORATION CO., LTD. |       |  |   |       |      |
|            |                         | LINEAR                     | ANGLE          |   |       |  | UNIT  | SHEET | VER. |
|            |                         | .X ± 0.30                  | X.' ± 5'       |   |       |  |  | 1/1   | AO   |
|            |                         | .XX ± 0.20                 | .X' ± 2'       |   |       |  |   |       |      |
|            |                         | .XXX ± 0.10                | .XX' ± 1'      | 名稱 : 2+N Male<br>TITLE :  |       |  |   |       |      |
|            |                         | 日期                         | 2023.03.24     | 料號 : WPB25-2XM  |       |  |   |       |      |
|            |                         | 審核                         | JASON          | PART NO. :  |       |  |   |       |      |
| 更改<br>REV. | 設 變 內 容<br>MODIFICATION | 修改<br>DRAWN                | 核准<br>APPROVED | 製 圖   | Jason |  |   |       |      |

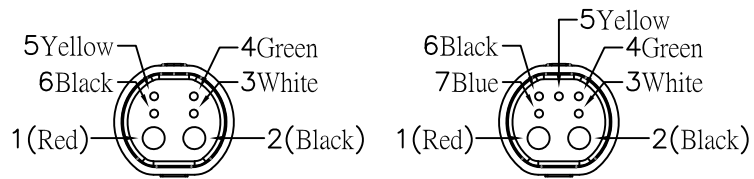

WPB25-24F 2+4

WPB25-25F 2+5

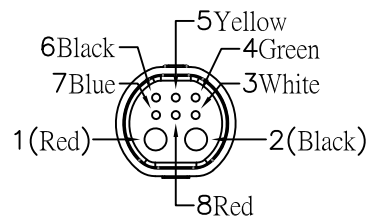

WPB25-26F 2+6

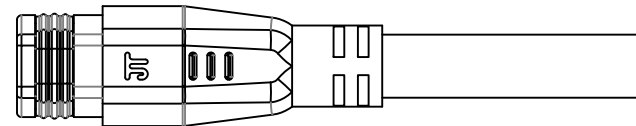
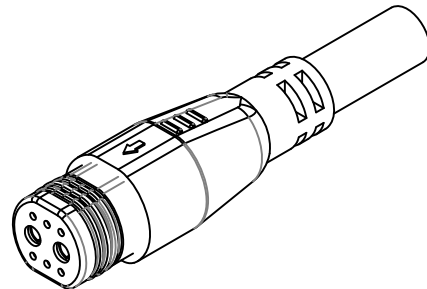
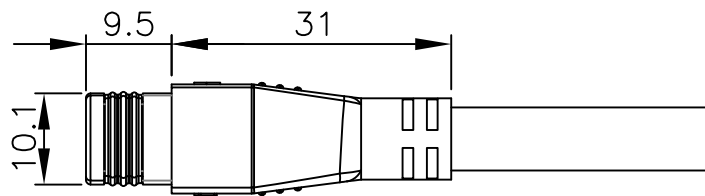
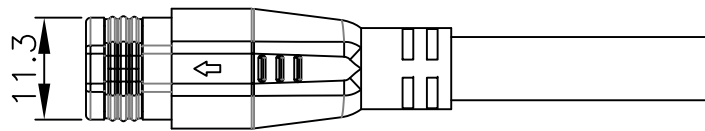
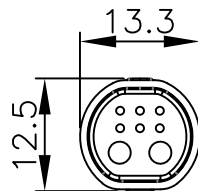

**Note:**

**1. Electrical Performance**

- 1.1 Rated current : 1~2 >= 25A / 4~8 >= 2A
- 1.2 Rated Voltage : 60 V
- 1.3 Insulation resistance : >= 20MΩ
- 1.4 Contact resistance : <= 10mΩ

**2. Mechanical Performance**

- 2.1 Durability Repeated : Insert and withdraw up to 100 cycles

**3. Environmental Performance**

- 3.1 Ingress Protection : IP67
- 3.2 Temperature Range - Operating : -40°C ~ +80°C

**4. Cables Shall Be 100% Tested For Opens And Short And Miss.**

|            |                         |                            |                |   |       |  |   |       |      |
|------------|-------------------------|----------------------------|----------------|---|-------|--|---|-------|------|
|            |                         | TOLERAMCE UNLESS SPECIFIED |                |  <b>朝富科技股份有限公司</b><br>JOIN TEK CORPORATION CO., LTD. |       |  |   |       |      |
|            |                         | LINEAR                     | ANGLE          |   |       |  | UNIT  | SHEET | VER. |
|            |                         | .X ± 0.30                  | X' ± 5'        |   |       |  |  | 1/1   | AO   |
|            |                         | .XX ± 0.20                 | .X' ± 2'       |   |       |  |   |       |      |
|            |                         | .XXX ± 0.10                | .XX' ± 1'      | 名稱 : 2+N Female<br>TITLE :  |       |  |   |       |      |
|            |                         | 日期                         | 2023.03.24     | 料號 : WPB25-2XF  |       |  |   |       |      |
|            |                         | 審核                         | JASON          | PART NO. :  |       |  |   |       |      |
| 更改<br>REV. | 設 變 內 容<br>MODIFICATION | 修改<br>DRAWN                | 核准<br>APPROVED | 製 圖   | Jason |  |   |       |      |