

※Note

- 1.Material: Brass
- 2.Surface Treatment: Niplating
- 3.WIRERANGE : AWG#14-20

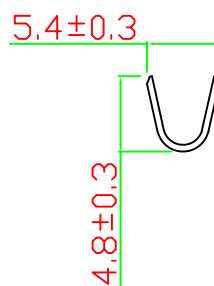
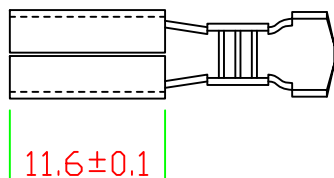
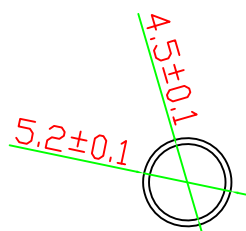

No.	ITEM	BILL OF MATERIAL	QTY	更改 REV.	設 變 內 容 MODIFICATION	修改 DRAWN	核准 APPROVED	TOLERANCE UNLESS SPECIFIED		日期	2022.03.29	名稱 : 子彈頭端子(母) TITLE	料號 : J8525A-F45-220 PART NO.	
								LINEAR	ANGLE					
								.X ± 0.30	X.* ± 5°			UNIT	SHEET	VER.
								.XX ± 0.20	.X.* ± 2°			1/1	A0	
								.XXX ± 0.10	.XX.* ± 1°					
				A0	New Release			審 核	JASON	製 圖	Jackie			

**朝富科技股份有限公司**  
 JOIN TEK CORPORATION CO., LTD.

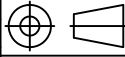

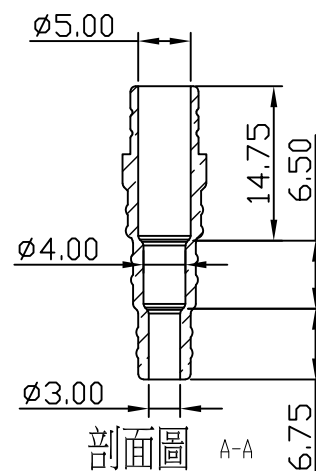
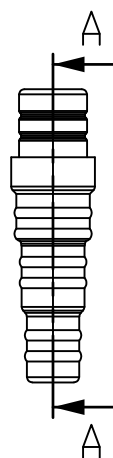
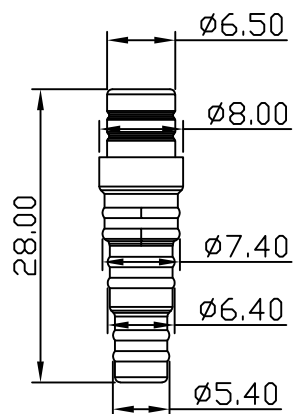
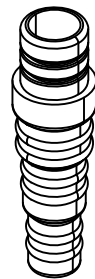

 UNIT SHEET VER.  
 1/1 A0  
 名稱 : 子彈頭端子(母)  
 TITLE  
 料號 : J8525A-F45-220  
 PART NO.

RoHS



剖面圖 A-A

比例 1:1

				TOLERANCE UNLESS SPECIFIED		 朝富科技股份有限公司 JOIN TEK JOIN TEK CORPORATION CO., LTD.		
				LINEAR	ANGLE			
				.X ± 0.20	X.* ± 5°	 SCALE	 SHEET	 VER.
				.XX ± 0.10	.X.* ± 2°			
				.XXX ± 0.05	.XX.* ± 1°	名稱: ø4.5子彈頭母矽膠護套 TITLE:		
				日期	2021.12.28	料號: Jacket-SI-4.5-F		
				審核		PART NO.		
更改 REV.	設 變 內 容 MODIFICATION	繪 改 DRAWN	核 准 APPROVED	製 圖	JASON			